

1 MILLWORK SECTION
A7.4 SCALE: 1 1/2" = 1'-0"

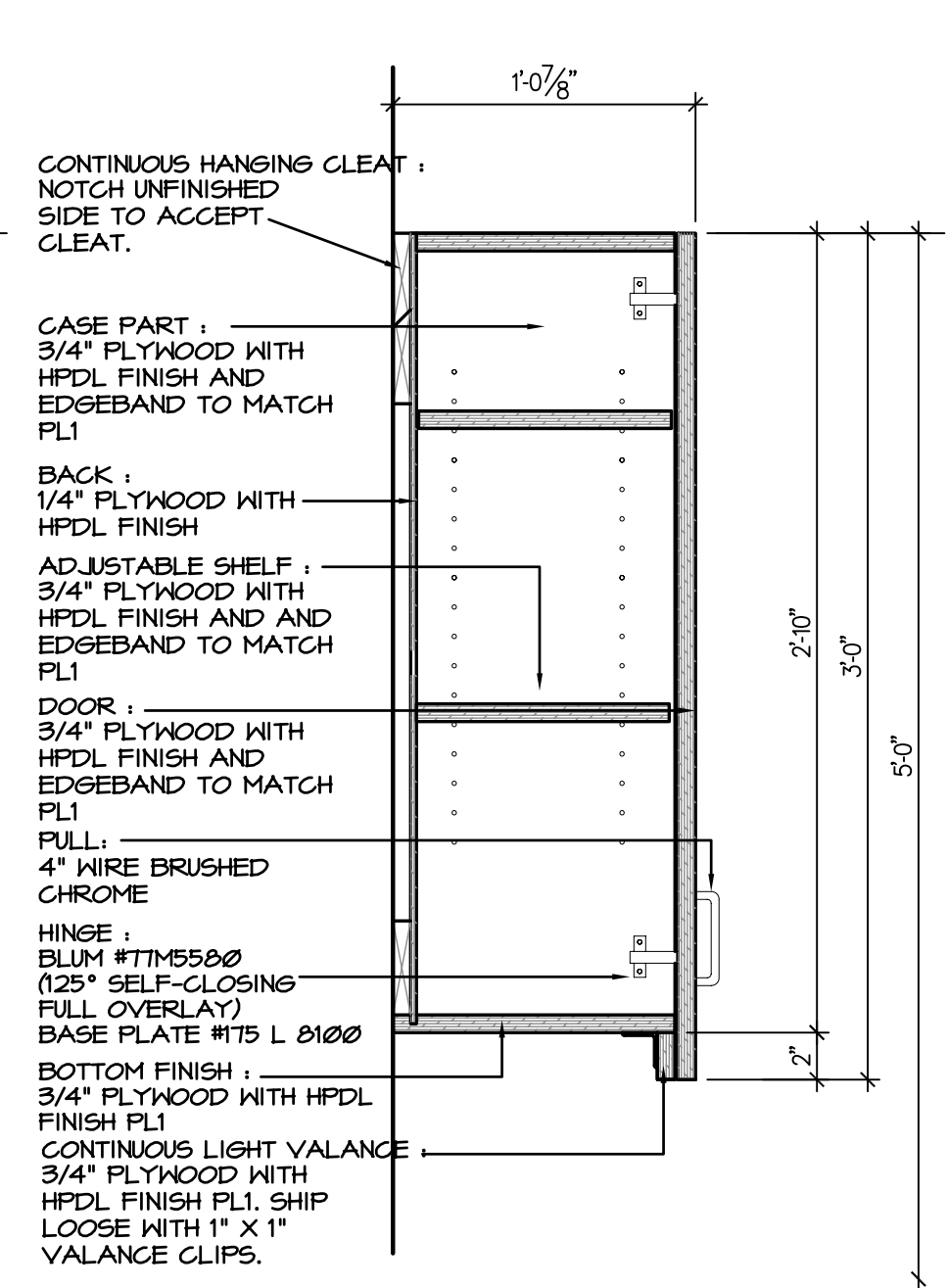

7 MILLWORK SECTION
A7.4 SCALE: 1 1/2" = 1'-0"

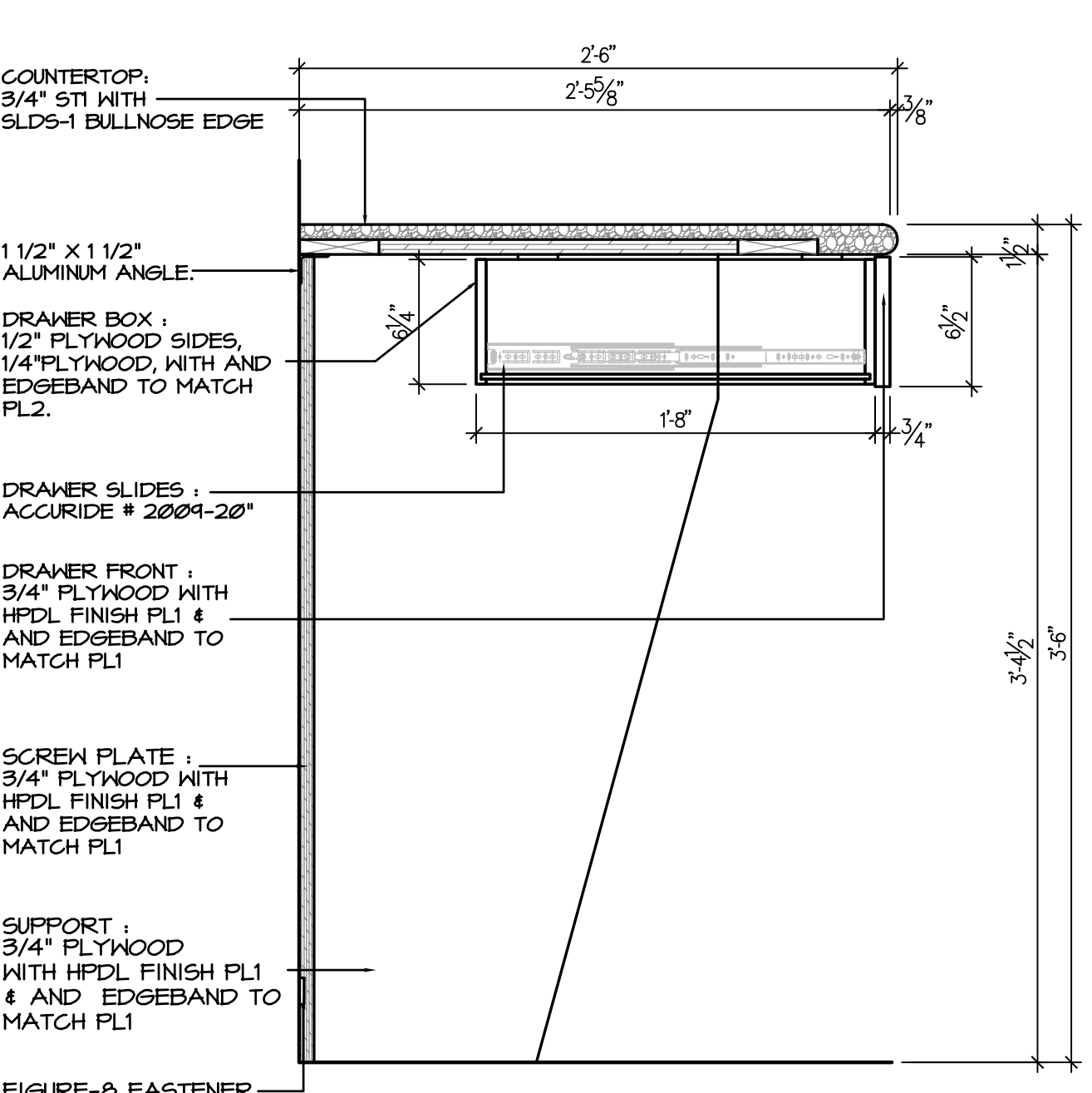

8 MILLWORK SECTION
A7.4 SCALE: 1 1/2" = 1'-0"

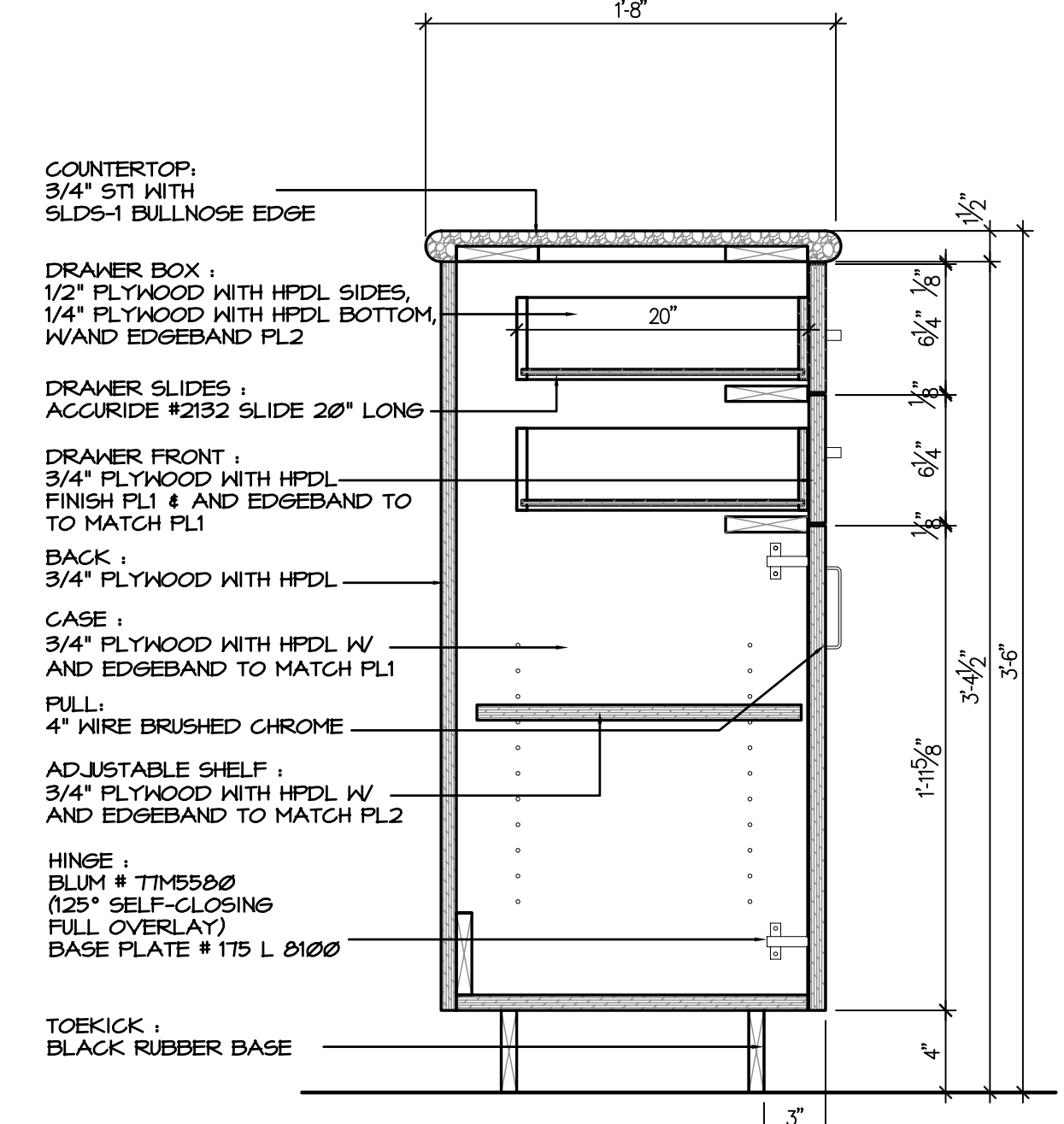

9 MILLWORK SECTION
A7.4 SCALE: 1 1/2" = 1'-0"

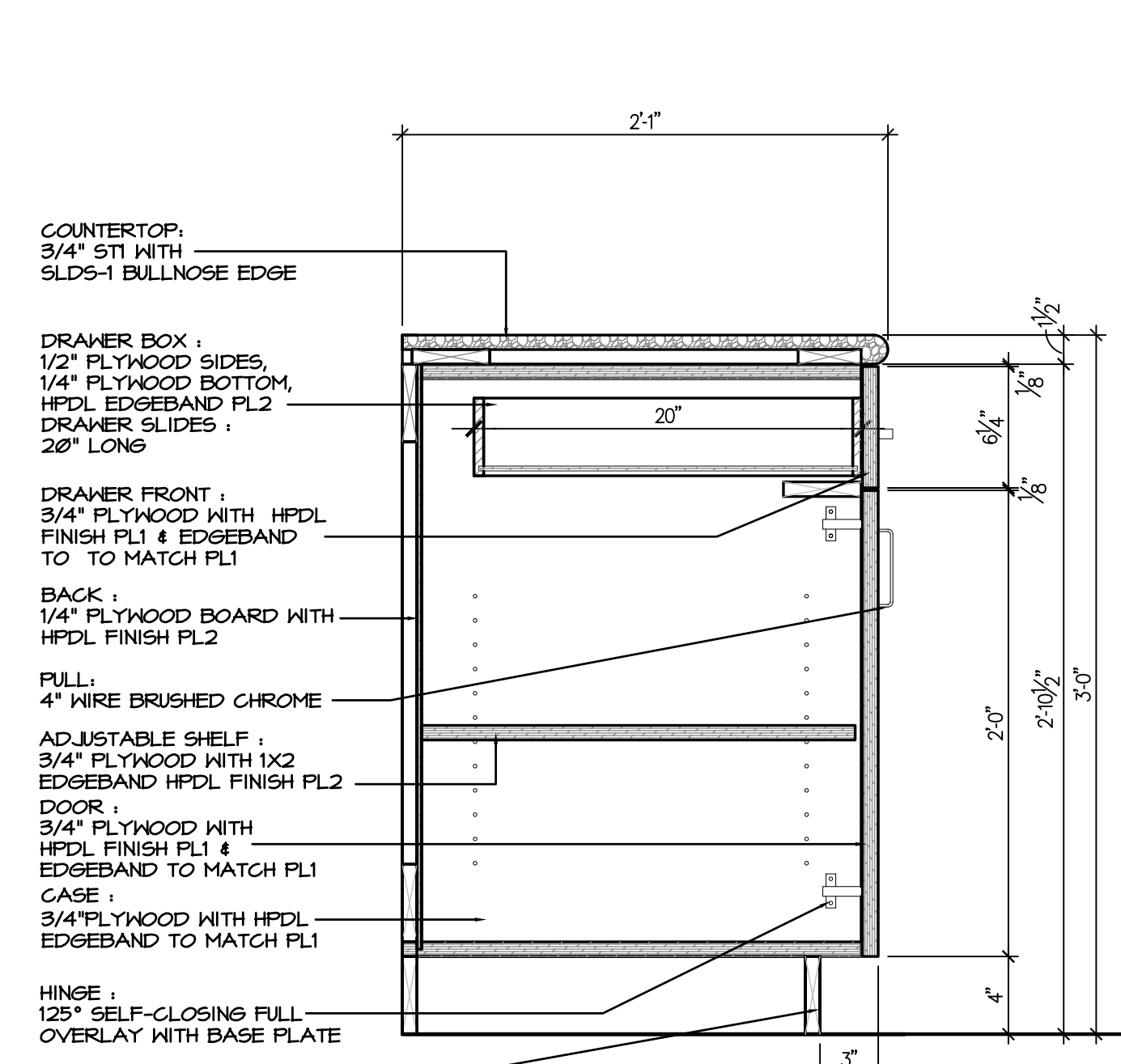

10 MILLWORK SECTION
A7.4 SCALE: 1 1/2" = 1'-0"

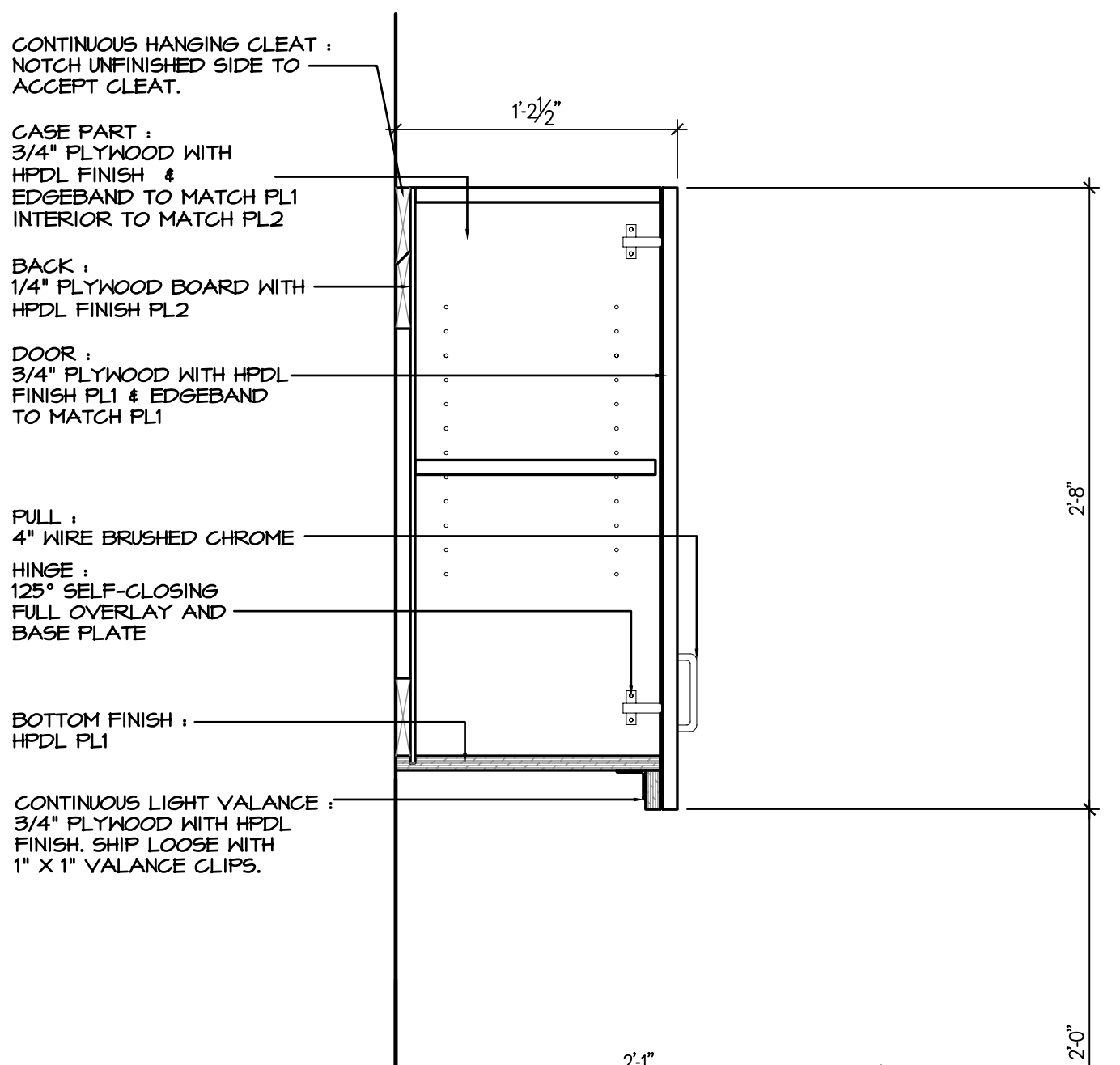

1 MILLWORK SECTION
A7.4 SCALE: 1 1/2" = 1'-0"

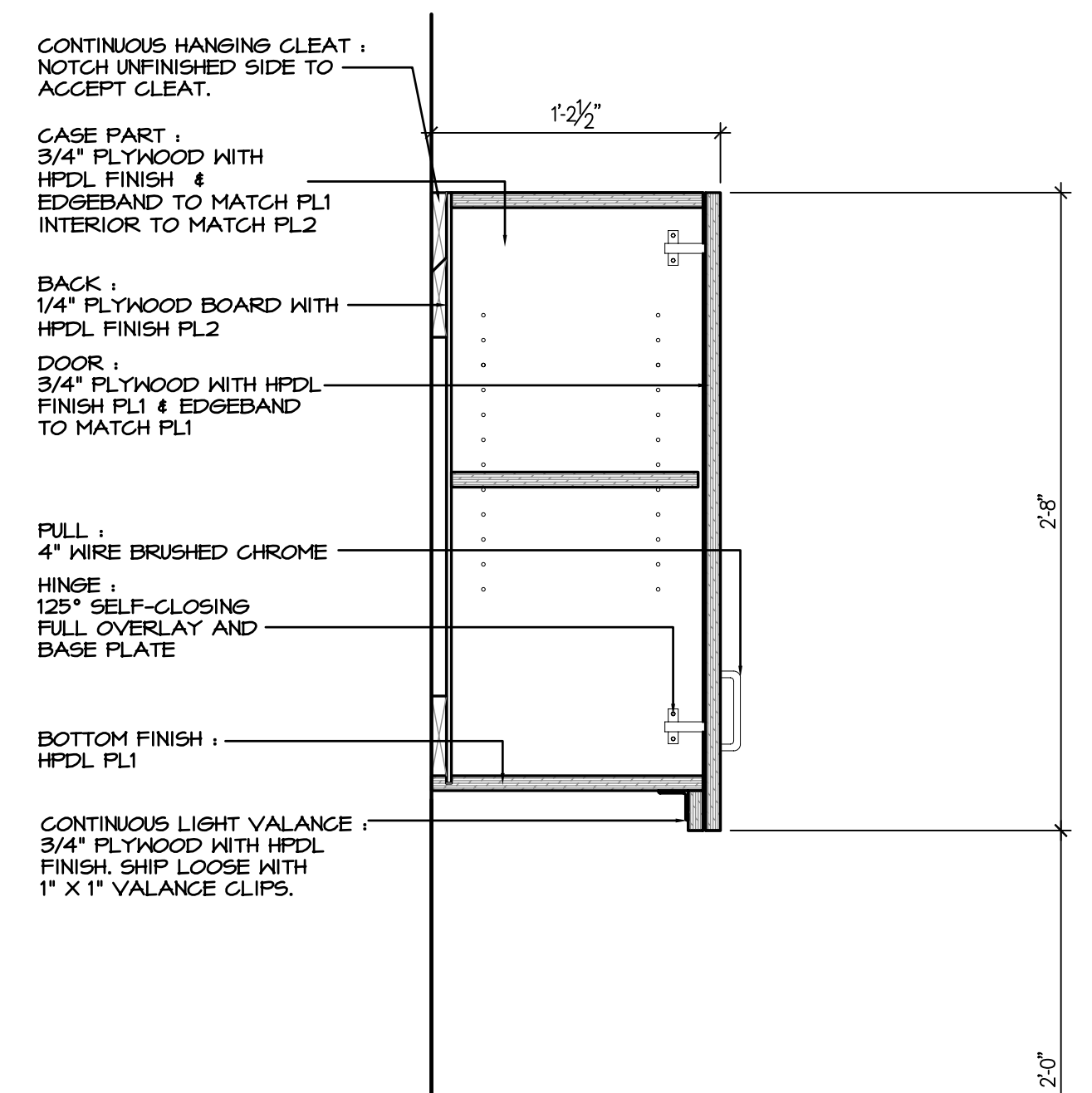

2 MILLWORK SECTION
A7.4 SCALE: 1 1/2" = 1'-0"

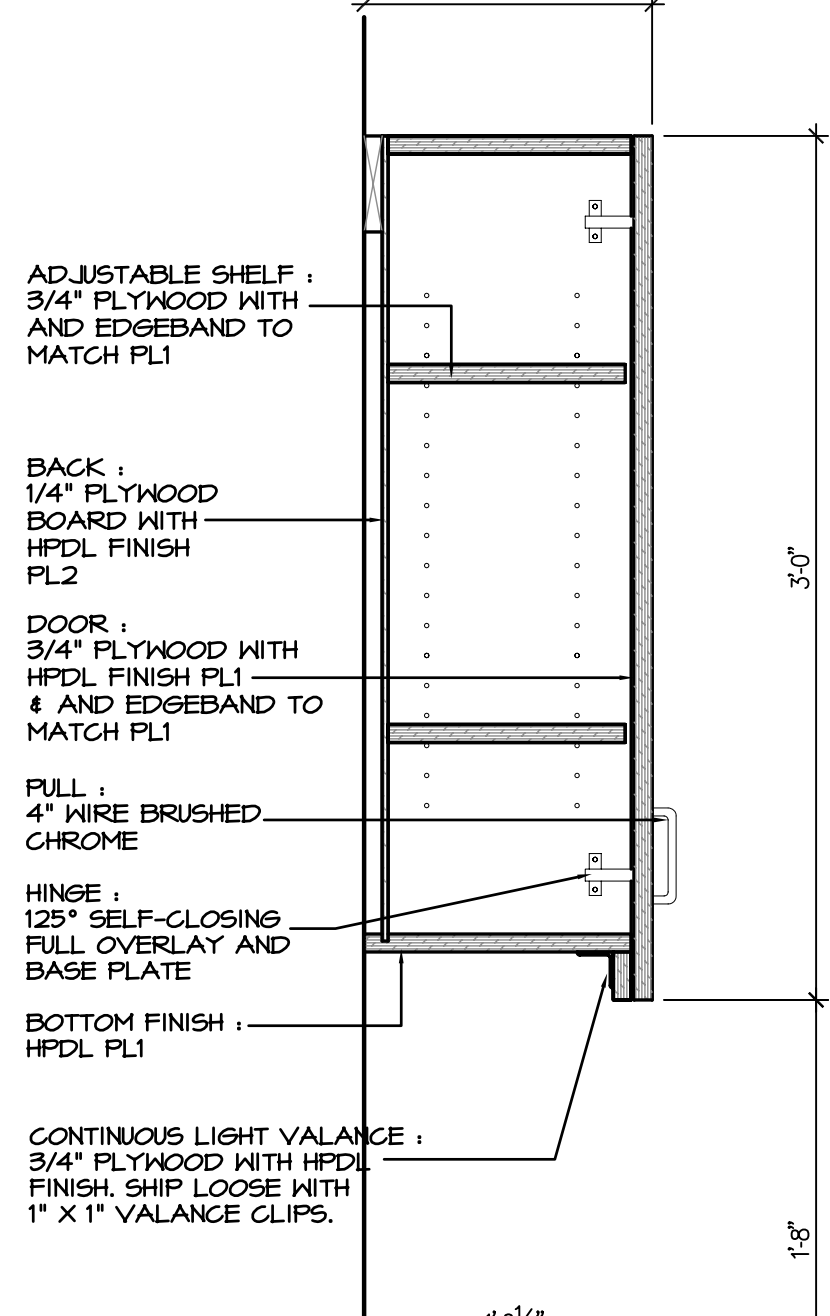

3 MILLWORK SECTION
A7.4 SCALE: 1 1/2" = 1'-0"

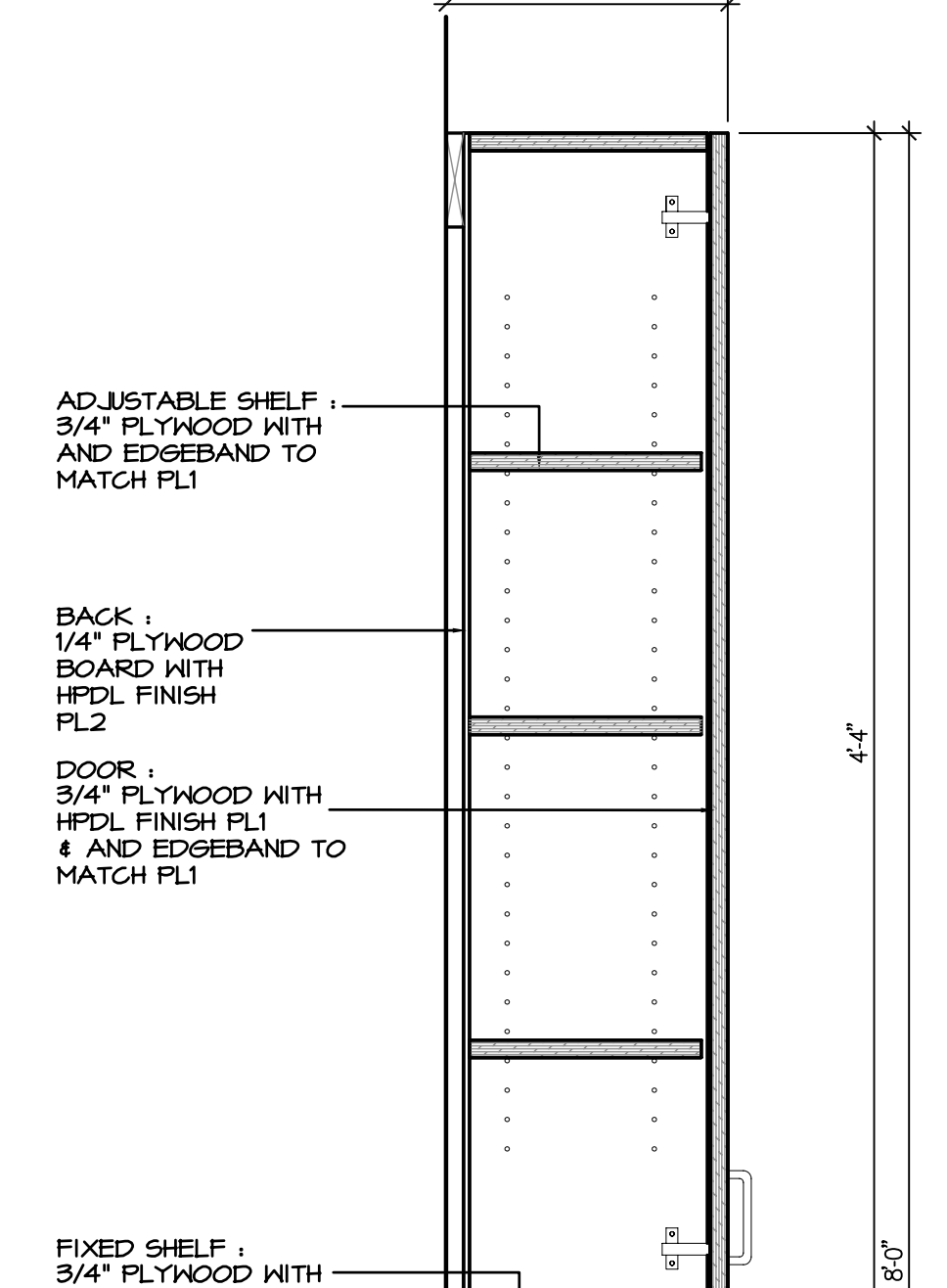

4 MILLWORK SECTION
A7.4 SCALE: 1 1/2" = 1'-0"

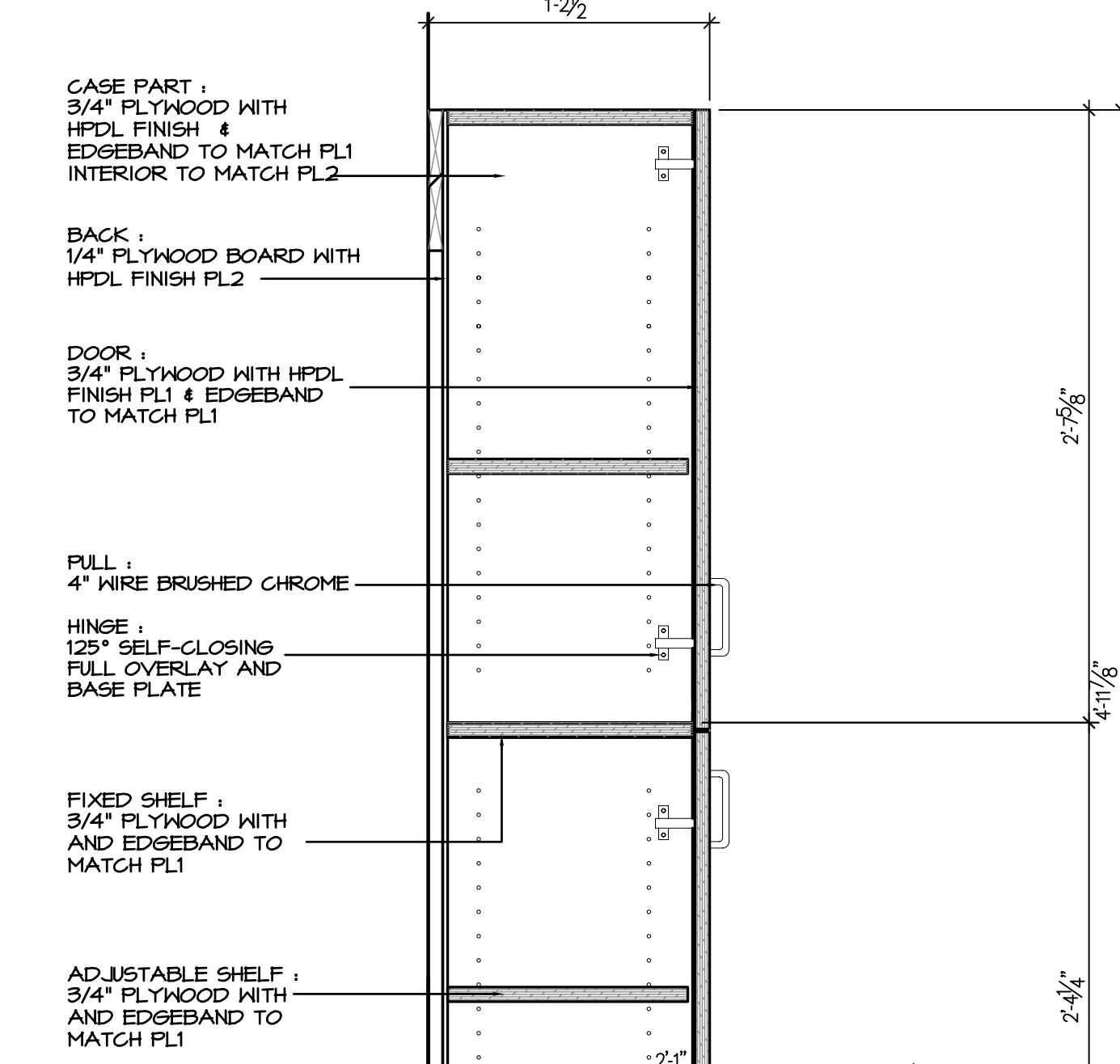

5 MILLWORK SECTION
A7.4 SCALE: 1 1/2" = 1'-0"

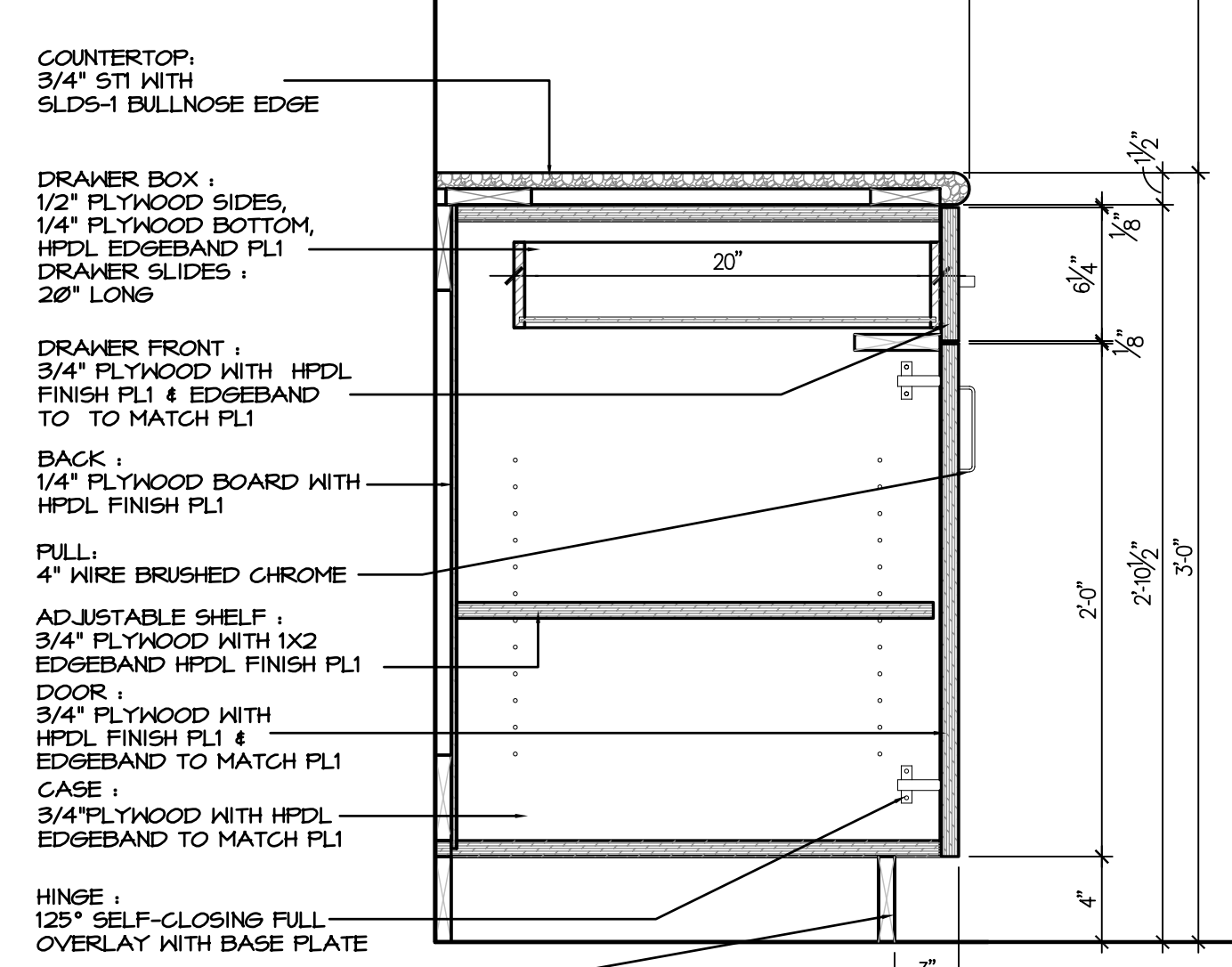

1 MILLWORK SECTION
A7.4 SCALE: 1 1/2" = 1'-0"

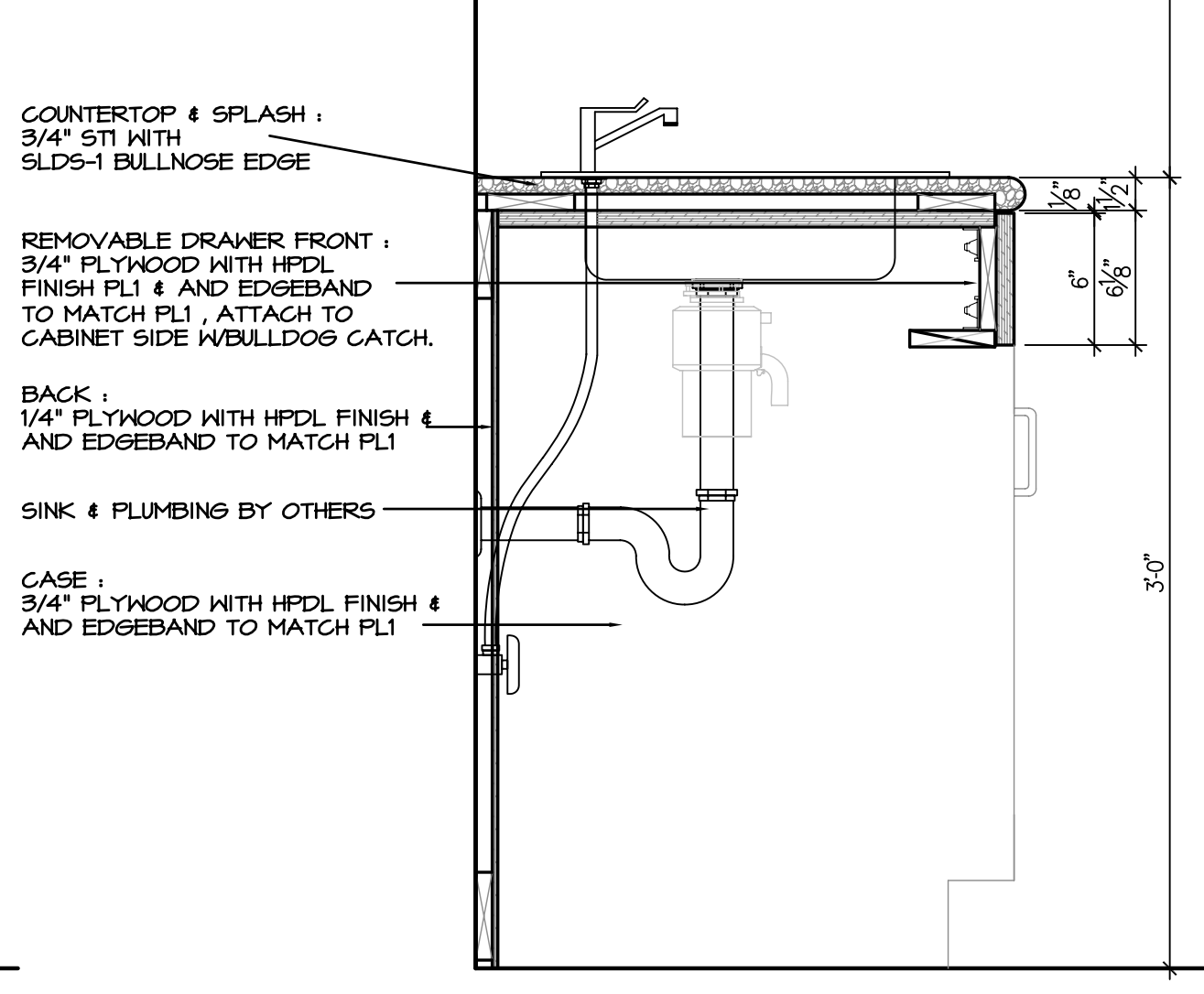

2 MILLWORK SECTION
A7.4 SCALE: 1 1/2" = 1'-0"

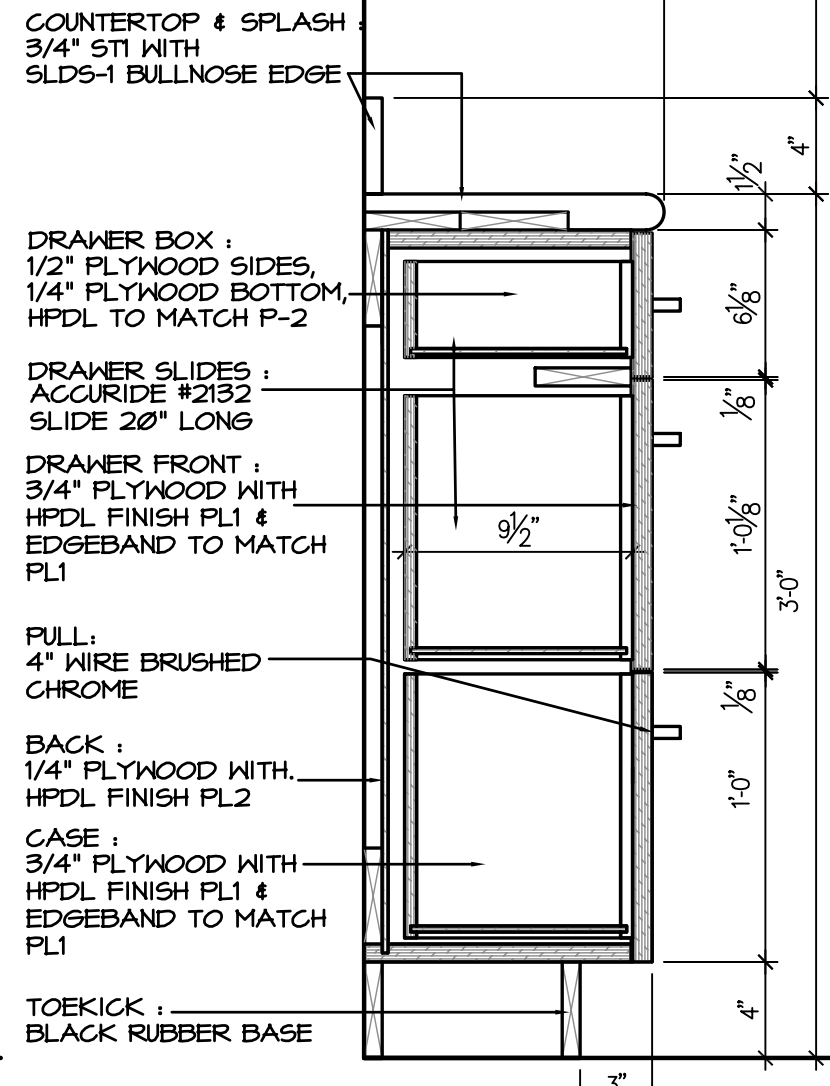

3 MILLWORK SECTION
A7.4 SCALE: 1 1/2" = 1'-0"

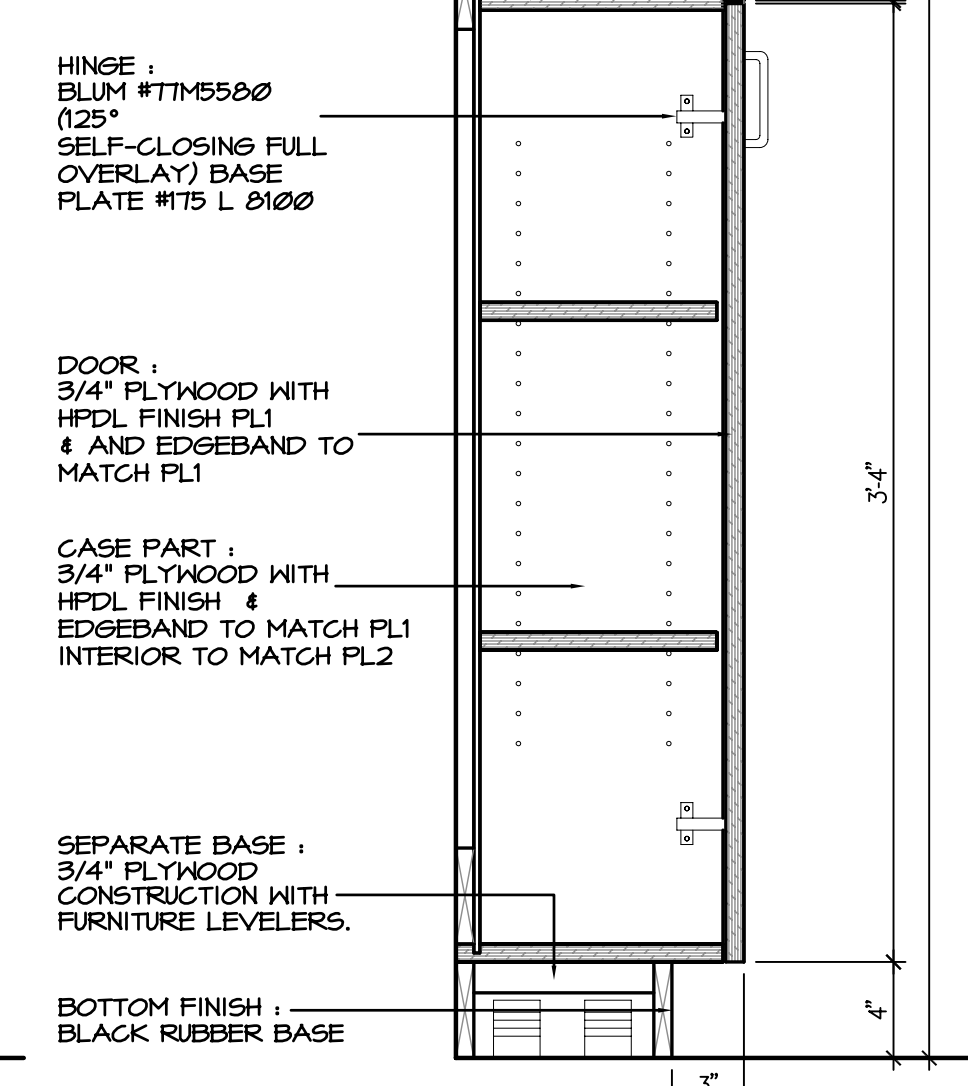

4 MILLWORK SECTION
A7.4 SCALE: 1 1/2" = 1'-0"

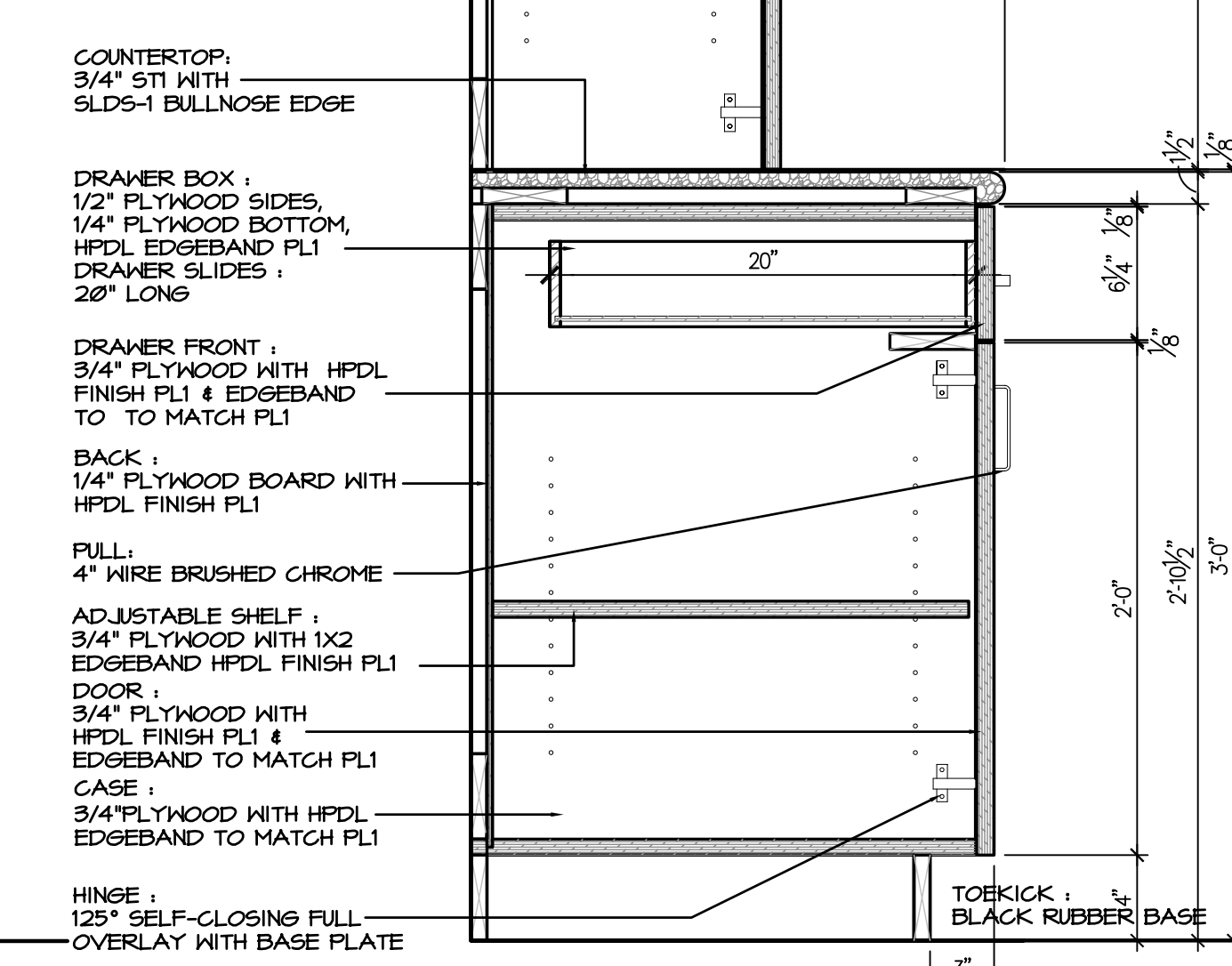

5 MILLWORK SECTION
A7.4 SCALE: 1 1/2" = 1'-0"

Hermes Architects

Members A.I.A.
1177 West Loop South, Ste. 500
Houston, Texas 77027
Tel. 713-785-3644
www.hermesarchitects.com
Houston • Dallas • Ft. Worth

This document is an instrument of service protected by the copyright law of the United States of America, 17 U.S.C. § 102, and shall not be copied or reproduced without the express written consent of Hermes Architects, Inc.



Shaw's Jewelers
West Gray
1021 West Gray Ave.
Houston, Texas

Shaw's Jewelers
1014 West Gray Street
Houston, Texas 77019

DATE	11.11.2011
PROJECT NO.	1102100
DRAWN BY	--
CHECKED BY	--

Interior Details

A7.4

K:\1102100\DRAWINGS\4-PLOT SHEETS\A7.4 INTERIOR DETAILS.DWG 11/9/2011 10:44:43 AM DARREN PENEWITT